



Project Name : Untitled project 2025-02-12 20:29:09.346	Project ID :
Company Name :	
Department :	
Phone number :	
e-mail address :	

Requested Data

Flow : 1.068 m ³ /h	Fluid : Water
Head : 41.15 m	Density : 0.9983 kg/dm ³
	Viscosity : 1.005 mm ² /s
	Temperature : 20 °C
	Vapour pressure at t A : 0.0234 bar

Pump

Operating Data

Pump Model : MVS-1/07T	Flow : 1.057 m ³ /h
No. of Stages : 7	Head : 40.32 m
Inlet / Outlet size : 25	Shutoff Head : 43.31 m
Speed : 2900 1/min	Efficiency : 40.8 %
Direction of Rotation : Counter clockwise	
Impeller type : Radial impeller	
Impeller Design : Closed	
Pump Weight (Approx) : 18 kg	
Pump Standard : CRI Standard	

Motor

Motor Model : MV 3P 0.5HP (IE2)	Insulation Class : F
Frequency/Efficiency class : 50 Hz IE2 = High Efficiency	Frame size : 71
Rated Voltage : 380V-415V λ / 220V-240V Δ	Degree of Protection : IP 55
Rated current : 1.0A / 1.6A	Method of Starting : Direct starting
Phase / Rated Power P2 : 3~ 0.37 kW	Service factor : 1
Speed : 2750 1/min	Power factor : 0.76
Efficiency : 69.5 %	
Motor Weight (Approx) : 7 kg	
Motor Standard : IEC-60034-30 / IS-12615	

Material of Construction

Flange Connections

Pump Outer Shell : AISI 304	Suction Flange Pressure rating : PN 25 Nominal pipe size : DN 25 Standard : DIN EN 1092-1:2008-09 Discharge Flange Pressure rating : PN 25 Nominal pipe size : DN 25 Standard : DIN EN 1092-1:2008-09
Pump Head : C.I	
Pump Head Cover : AISI 304	
Pump Base : AISI 304	
Base Plate : C.I	
Impeller : AISI 304	
MECHANICAL SEAL : SiC/SiC/FKM	
Bush : SiC / SiC	
Diffuser (Chamber) : AISI 304	
Pump Shaft : AISI 431	
Wearing Ring : Teflon	
O Ring : EPDM	
Coupling : Mild Steel	



Project Name : Untitled project 2025-02-12 20:29:09.346

Project ID :

Company Name :
Department :
Phone number :
e-mail address :

Curve Tolerance ISO : 9906, Grade-3B

Speed 2900 rpm

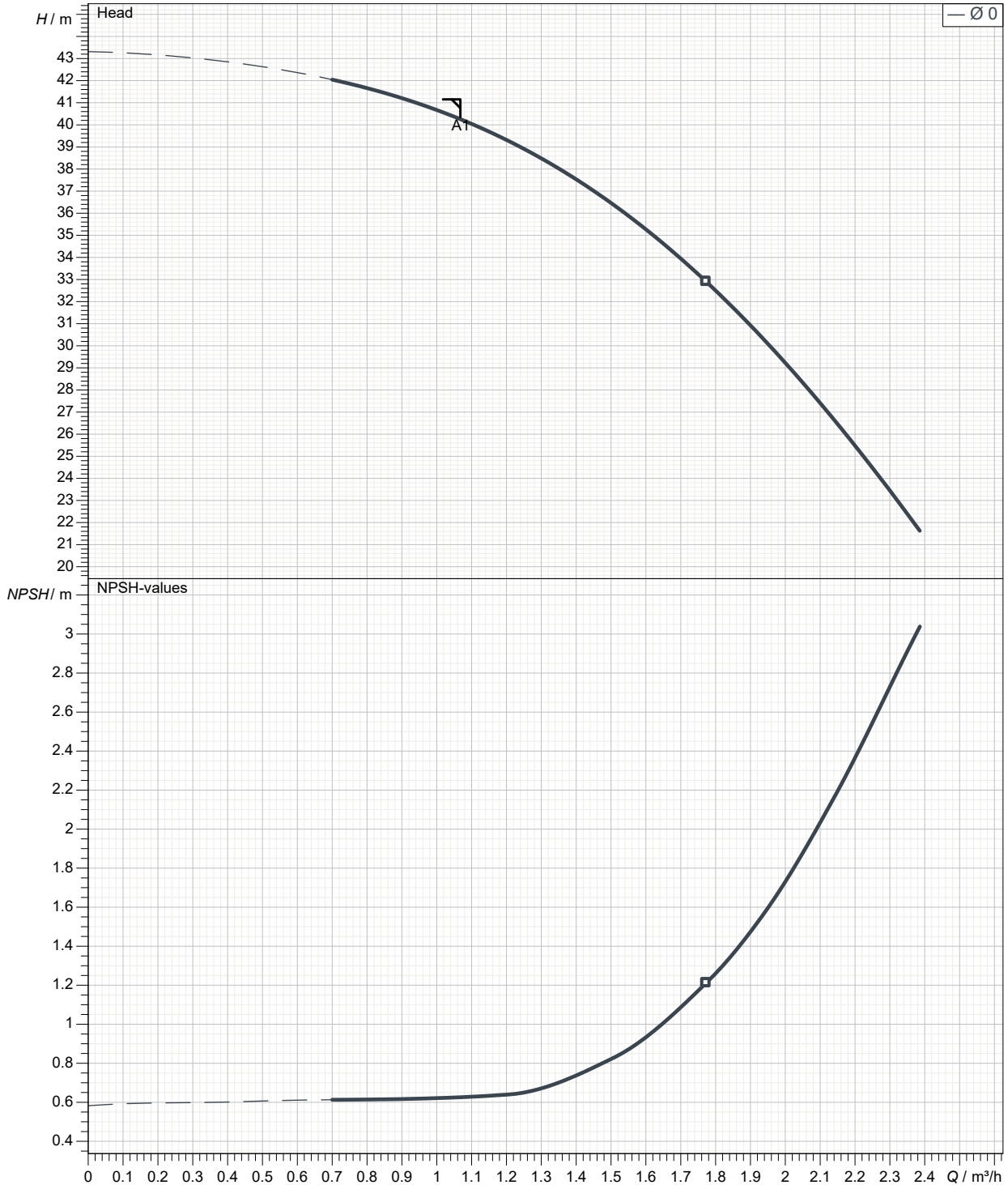



Project Name : Untitled project 2025-02-12 20:29:09.346

Project ID :

Company Name :
Department :
Phone number :
e-mail address :

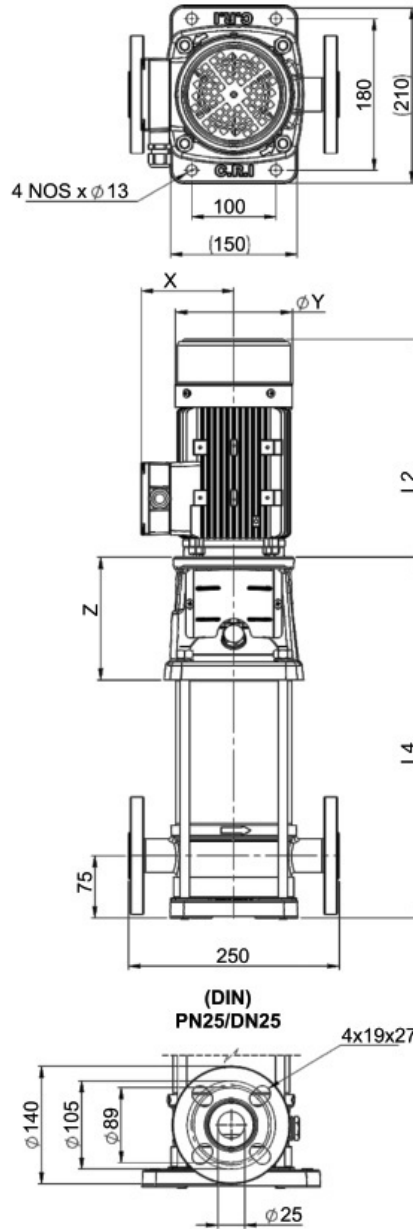

In View of continuous developments, The information/specifications/Description/ Illustrations are subject to change without notice.

Dimensions inmm

L2	240		
L4	363		
X	112		
Y	139		
Z	146		